

Understanding Power & Power Quality Measurements

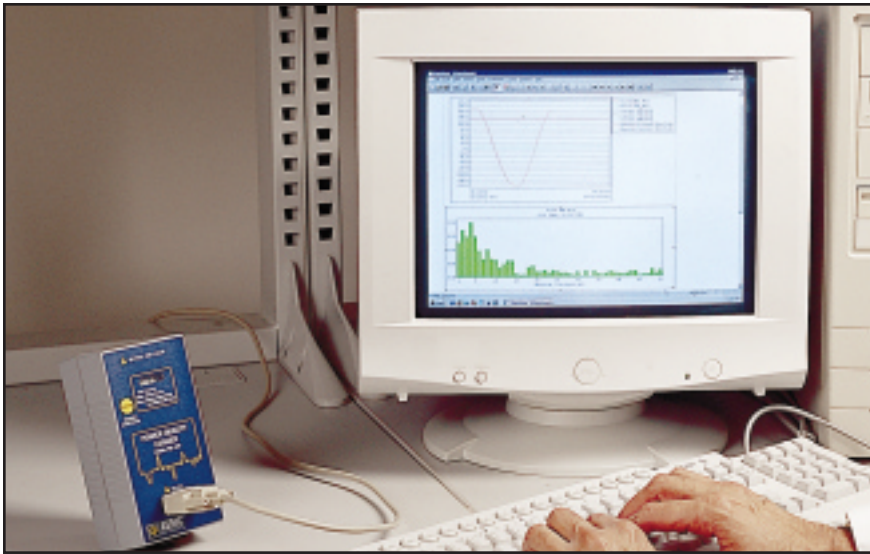

The threatened limitations of conventional electrical power sources have focused a great deal of attention on power, its application, monitoring and correction. Power economics now play a critical role in industry as never before. With the high cost of power generation, transmission, and distribution, it is of paramount concern to effectively monitor and control the use of energy.

The electric utility's primary goal is to meet the power demand of its customers at all times and under all conditions. But as the electrical demand grows in size and complexity, modifications and additions to existing electric power networks have become increasingly expensive. The measuring and monitoring of electric power have become even more critical because of down time associated with equipment breakdown and material failures.

For economic reasons, electric power is generated by utility companies at relatively high voltages (4160, 6900, 13,800 volts are typical). These high voltages are then reduced at the consumption site by step-down transformers to lower values which may be safely and more easily used in commercial, industrial and residential applications.

Personnel and property safety are the most important factors in the operation of electrical system operation. Reliability is the first consideration in providing safety. The reliability of any electrical system depends upon knowledge,

preventive maintenance and subsequently the test equipment used to monitor that system.

Typical Voltage Configurations

Single-Phase Systems

Single-phase residential loads are almost universally supplied through 120/240V, 3-wire, single-phase services. Large appliances such as ranges, water heaters, and clothes dryers are supplied at 240V. Lighting, small appliances, and outlet receptacles are supplied at 120V. In this system the two "hot" or current carrying conductors are 180° out-of-phase with respect to the neutral.

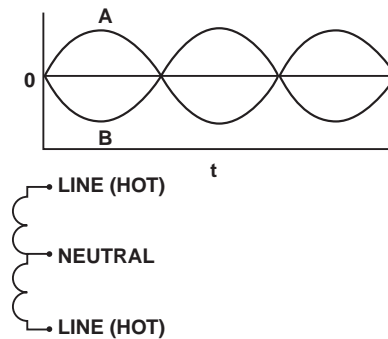

Figure 1. 1Ø System

Three-Phase, 3-Wire Systems

In this type of system, commonly known as the "DELTA" configuration, the voltage between each pair of line wires is the actual transformer voltage. This system is frequently used for

power loads in commercial and industrial buildings. In such cases, service to the premises is made at 208V, three-phase. Feeders carry the power to panel boards supplying branch circuits for motor loads. Lighting loads are usually handled by a separate single-phase service. The 480V distribution is often used in industrial buildings with substantial motor loads.

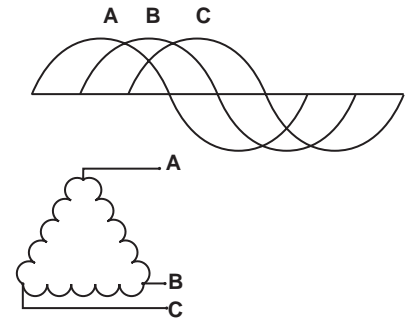

Figure 2. 3Ø, 3-wire system

Three-Phase, 4-Wire Systems

Known as the "WYE" type connection, this is the system most commonly used in commercial and industrial buildings. In office or other commercial buildings, the 480V three-phase, 4-wire feeders are carried to each floor, where 480V three-phase is tapped to a power panel or motors. General area fluorescent lighting that uses 277V ballasts is connected between each leg and neutral; 208Y/120 three-phase, 4-wire circuits are derived from step-down transformers for local lighting and receptacle outlets.

Typical voltage:

phase-to-phase = 208/480V
phase-to-neutral = 120/277V

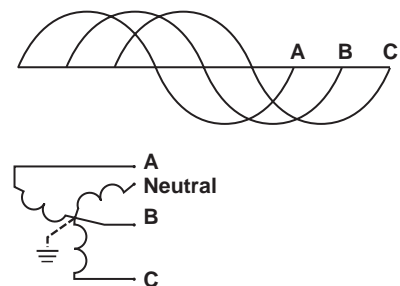

Figure 3. 3Ø, 4-Wire System

Balanced vs. Unbalanced Loads

A balanced load is an AC power system using more than two wires, where the current flow is equal in each of the current carrying conductors. Many systems today represent an

unbalanced condition due to uneven loading on a particular phase. This often occurs when electrical expansion is affected with little regard to even distribution of loads between phases or several nonlinear loads on the same system.

RMS vs. Average Sensing

The term RMS (root-mean-square) is used in relation to alternating current waveforms and simply means "equivalent" or "effective," referring to the amount of work done by the equivalent value of direct current (DC). The term RMS is necessary to describe the value of alternating current, which is constantly changing in amplitude and polarity at regular intervals. RMS measurements provide a more accurate representation of actual current or voltage values. This is very important for nonlinear (distorted) waveforms.

Until recently, most loads were "linear"; that is, the load impedance remained essentially constant regardless of the applied voltage. With expanding markets of computers, uninterruptible power supplies, and variable speed motor drives, resulting nonlinear waveforms are drastically different.

Measuring nonsinusoidal voltage and current waveforms requires a True RMS meter. Conventional meters usually measure the average value of amplitudes of a waveform. Some meters are calibrated to read the equivalent RMS value (.707 x peak); this type calibration is a true representation only when the waveform is a pure sine wave (i.e., no distortion). When distortion occurs, the relationship between average readings and True RMS values changes drastically. Only a meter which measures True RMS values gives accurate readings for a nonsinusoidal waveform. RMS measuring circuits sample the input signal at a high rate of speed. The meter's internal circuitry digitizes and squares each sample, adds it to the previous samples squared, and takes the square root of the total. This is the True RMS value.

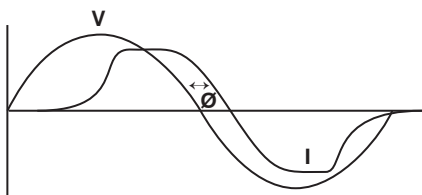

Figure 4. Nonlinear current waveform

Demand

The amount of electrical energy consumed over time is known as demand. Demand is the average load placed on the utility to provide power (kilowatts) to a customer over a utility-specified time interval (typically 15 or 30 minutes). If demand requirements are irregular, the utility must have more capability available than would be required if the customer load requirements remained constant. To provide for this time-varying demand, the utility must invest in the proper size equipment to provide for these power peaks. Brief high peaks such as those present when large equipment initially comes on line are not critical in the overall equation because the duration is short with respect to the demand averaging interval.

Consumption

Watts and vars are instantaneous measurements representing what is happening in a circuit at any given moment. Since these parameters vary so greatly within any period, it is necessary to integrate (sum) electrical usage over time.

The fundamental unit for measuring usage is the watthour (Wh), or more typically the kilowatthour (kWh). This value represents usage of 1000W for one hour. Typical costs in the United States for one kilowatthour range from 8 to 15 cents.

Power Factor

Power factor is the ratio of ACTUAL POWER used in a circuit to the APPARENT POWER delivered by a utility. Actual power is expressed in watts (W) or kilowatts (kW); apparent power in voltamperes (VA) or kilovoltamperes (kVA). Apparent power is calculated simply by multiplying the current by the voltage.

$$\text{Power Factor} = \frac{\text{Actual Power} = \text{kW}}{\text{Apparent Power kVA}}$$

Certain loads (e.g., inductive type motors) create a phase shift or delay between the current and voltage waveforms. An inductive type load causes the current to lag the voltage by some angle, known as the phase angle.

On purely resistive loads, there is no phase difference between the two waveforms; therefore the power factor on such a load will be 0 degrees, or unity.

The following examples of a soldering iron and a single-phase motor illustrate how power factor is consumed in different types of loads. In a soldering iron, the apparent power supplied by the utility is directly converted into heat, or actual power. In this case, the actual power is equal to the apparent power, so that the power factor is equal to "1" or 100% (unity).

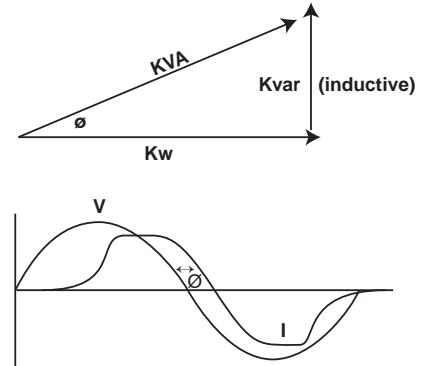

Figure 5. Power factor on nondistorted sine wave.

In the case of a single-phase motor, the actual power is the sum of several components:

- the work performed by the system; that is, lifting with a crane, moving air with a fan, or moving material, as with a conveyer.
- heat developed by the power lost in the motor winding resistance
- heat developed in the iron through eddy currents and hysteresis losses
- frictional losses in the motor bearings
- air friction losses in turning the motor rotor, more commonly known as windage losses.

We now observe that with a single-phase motor, the apparent power obtained is greater than the actual power. This difference is the power factor.

Power factor reflects the difference which exists between loads. The soldering iron is a purely resistive load which absorbs the current, which is then absorbed directly into heat. The current is called actual current because it directly contributes to the production of actual power.

On the other hand, the single-phase electric motor represents a partially inductive load consisting of actual current which will be converted into actual power, and magnetizing current which generates the magnetic field required to operate the electric motor.

This magnetizing current, called the reactive current, corresponds to an exchange of energy between the generator and the motor, but it is not converted into actual power.

Reactive Compensation Power

Reactive compensation power refers to the capacitive values required to correct low power factor to as close to unity (1.0) as possible. Most industrial loads are inductive, so the load current lags the line voltage by some degree. In order to bring the value closer to unity, something must be added to the load to draw a leading current. This is done by connecting a capacitor in parallel with the load. Since a capacitor will not dissipate any real power, the charge for real power will be the same.

Several AEMC power monitoring instruments will display the actual power factor correction capacitor values directly. AEMC recommends consulting a power factor correction capacitor manufacturer prior to any installation to reduce the possible effects of harmonics, resonance, etc.

Electrical Harmonics

Until fairly recently, power quality referred to the ability of the electric utilities to supply electric power without interruption. Today, the phrase encompasses any deviation from a perfect sinusoidal waveform. Power quality now relates to short-term transients as well as continuous state distortions. Power system harmonics are a continuous state problem with dangerous results. Harmonics can be present in current, voltage, or both. It is estimated that as many as 60% of all electrical devices operate with non-linear current draw.

Utility companies invest millions of dollars each year to ensure that voltage supplied to their customers is as close as possible to a sinusoidal waveform. If the power user connects loads to the system which are resistive, such as incandescent light bulb, the resulting current waveform will also be sinusoidal. However, if the loads are nonlinear, which is typically the case, the current is drawn in short pulses and the current waveform will be distorted. Total current that is then drawn by the nonlinear load would be the fundamental as well as all the harmonics.

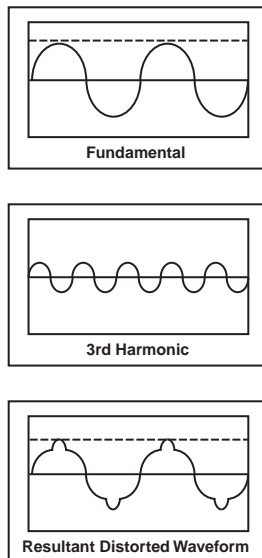

Figure 6. Composite waveform

Harmonic distortion can cause serious problems for the users of electric power, from inadvertent tripping of circuit breakers to dangerous overheating of transformers and neutral conductors, as well as heating in motors and capacitor failure. Harmonics can cause problems that are easy to recognize but tough to diagnose.

It is becoming increasingly important to understand the fundamentals of harmonics, and to be able to recognize and monitor the presence of damaging harmonics. Harmonics within an electrical system vary greatly within different parts of the same distribution system and are not limited simply to the supply of the harmonic producing device. Harmonics can interact within the system through direct system connections or even through capacitive or inductive coupling.

A harmonic may be defined as an integer multiple of a fundamental frequency. Harmonics are designated by the harmonic number. For our discussion, we will focus on the 60Hz power frequency. The second harmonic would be two times the fundamental or 120Hz. The third would be three times the fundamental or 180Hz, and so on.

Nonlinear equipment generates harmonic frequencies. The nonlinear nature of a device draws current waveforms that do not follow the voltage waveform. Electronic equipment is a good example. While this broad category encompasses many different

types of equipment, most of these devices have one characteristic in common. They rely on an internal DC power source for their operation.

Loads which produce harmonic currents include:

- Electronic lighting ballasts
- Adjustable speed drives
- Electric arc furnaces
- Personal computers
- Electric welding equipment
- Solid state rectifiers
- Industrial process controls
- UPS systems
- Saturated transformers
- Solid state elevator controls
- Medical equipment

This is by no means an exhaustive list of equipment which generates harmonics. Any electronic-based equipment should be suspected of producing harmonics.

Due to the ever increasing use of electronics, the percentage of equipment which generates harmonic current has increased significantly. The harmonic problem manifests itself with proliferation of equipment using diode-capacitor input power supplies. This type of equipment draws current in a short pulse only during the peak of the sine wave. The result of this action, aside from improved efficiency, is that high frequency harmonics are superimposed onto the fundamental 60Hz frequency.

The harmonics are produced by the diode-capacitor input section which rectifies the AC signal into DC. The circuit draws current from the line only during the peaks of the voltage waveform, thereby charging a capacitor to the peak of line voltage. The equipment DC requirements are fed from this capacitor and as a result the current waveform becomes distorted.

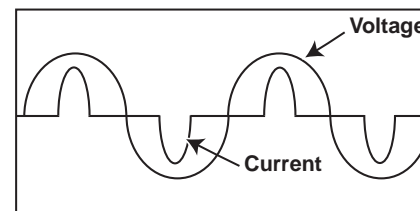

Figure 7 Nonlinear current draw

Harmonics in the electric power system combine with the fundamental frequency to create distortion. The level of distortion is directly related to the frequencies and amplitudes of the harmonic current. The contribution of all harmonic frequency currents to the fundamental current is known as "Total Harmonic Distortion" or THD. This THD value is expressed as a percentage of the fundamental current. THD values of over 10% are reason for concern.

THD is calculated as the square root of the sum of the squares of all the harmonics divided by the fundamental signal (50 or 60Hz). This calculation arrives at the value of distortion as a percentage of the fundamental.

Mathematically, %THD is the ratio of the sum of the root-mean-square (RMS) of the harmonic content to the root-meansquare (RMS) value of the fundamental 50 or 60Hz signal, and expressed as a percentage.

Another useful parameter is the Distortion Factor, or %DF. Distortion Factor is the Total Harmonic Distortion

square (RMS) of the harmonic content to the root-meansquare (RMS) value of the total signal, and expressed as a percentage.

Please note that our %DF is not the same value as the Distortion Factor as expressed the the IEEE standard 519-1992 (in which Distortion Factor is the same as THD).

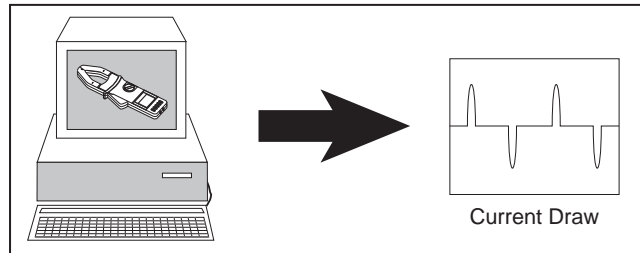

Figure 8. Computer current waveform

Wherever there are large numbers of nonlinear loads, there are sure to be harmonics in the distribution system. Harmonic-producing equipment is found in varied locations from administrative offices to manufacturing facilities. In the factory environment, electronic power converters such as

variable speed drives, SCR drives, etc., are the largest contributors to harmonic distortion. It is not uncommon to have THD levels as high as 25% within some industrial settings.

Most single-phase office equipment draws nonlinear current. While fluorescent lighting with electronic ballasts and many types of office equipment contribute to

creating harmonics, personal computer power supplies are the largest contributor within the office environment. Although THD levels will be lower than in an industrial setting, the susceptibility of office equipment to variations in power quality is extremely high.

In the industrial environment, there can be many three-phase, nonlinear loads drawing high levels of load current. The most prevalent harmonic frequencies are the odd integer multiples of the 60Hz frequency. The third harmonic (180Hz) is always the most prevalent and troublesome.

Large commercial buildings have many different sizes and types of loads. In most installations the power is distributed with 208/120V transformers in a Delta-Wye configuration. When multiple loads are supplied, each generates triple

harmonic currents on the neutral conductor which are sent onto the transformer secondary and reflected into the delta primary. These currents circulate within the delta primary causing overheating and shortened service life.

Harmonics can cause a variety of problems to any user of electric power. For large users, the problems can be intense. For electronic equipment that relies on the zero crossing of the sinusoidal waveform, such as clock timing devices, heavy harmonic content can cause a zero crossing point offset.

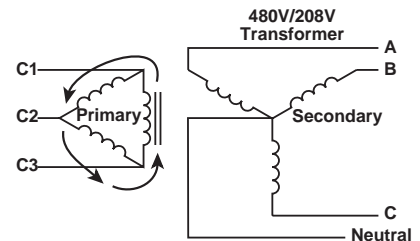

Figure 9. Delta primary, circulating current

Odd number harmonics (third, fifth and seventh) cause the greatest concern in the electrical distribution system. Because the harmonic waveform usually swings equally in both the positive and negative direction, the even number harmonics are mitigated.

Heating effect causes the greatest problem in electric equipment. Many times, electrical distribution equipment has overheated and failed even when operating well below the suggested rating requirements. Temperature increase is directly related to the increase in RMS current.

TOTAL HARMONIC DISTORTION

$$\%THD = \sqrt{\frac{\text{Sum of squares of amplitudes of all harmonics}}{\text{Square of amplitude of fundamental}}} \times 100$$

$$\%THD \text{ (current)} = \sqrt{\frac{[(I_2)^2 + (I_3)^2 + (I_4)^2 + (I_5)^2 \dots / (I_{RMS})^2]}{}} \times 100$$

$$\%THD \text{ (voltage)} = \sqrt{\frac{[(V_2)^2 + (V_3)^2 + (V_4)^2 + (V_5)^2 \dots / (V_1)^2]}{}} \times 100$$

DISTORTION FACTOR

$$\%DF = \sqrt{\frac{\text{Sum of squares of amplitudes of all harmonics}}{\text{Square of Total RMS}}} \times 100$$

$$\%DF \text{ (current)} = \sqrt{\frac{[(I_2)^2 + (I_3)^2 + (I_4)^2 + (I_5)^2 \dots / (I_{RMS})^2]}{}} \times 100$$

$$\%DF \text{ (voltage)} = \sqrt{\frac{[(V_2)^2 + (V_3)^2 + (V_4)^2 + (V_5)^2 \dots / (V_1)^2]}{}} \times 100$$

referenced to the total RMS signal. The THD is expressed as a percentage and may not be greater than the fundamental. The %DF never exceeds 100%. We provide this term because of the market need and the requirement of this value under the international standard IEC-555. Mathematically, it is the ratio of the sum of the root-mean-

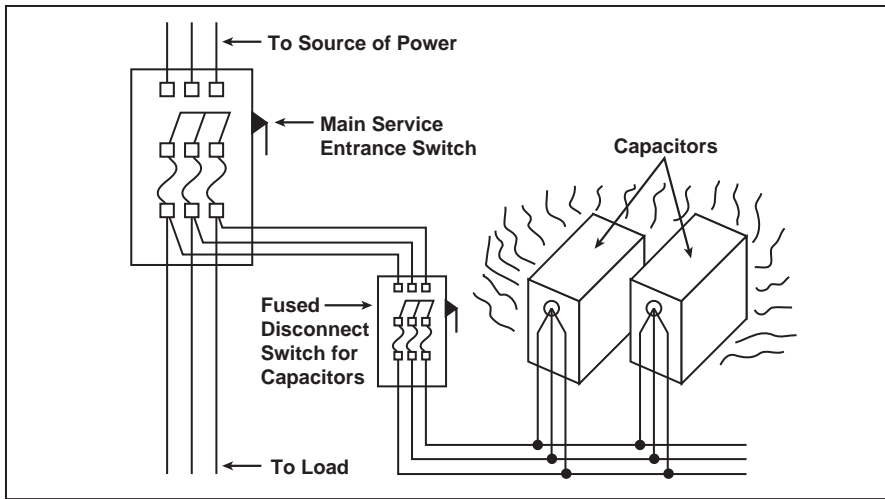

Figure 10. Power factor capacitors at resonant frequency.

Because harmonic frequencies are always higher than the 60Hz fundamental frequency, “skin effect” also becomes a factor. Skin effect is a phenomenon where the higher frequency causes the electrons to flow toward the outer sides of the conductor, effectively reducing the cross-sectional diameter of the conductor and thereby reducing the ampacity rating of the cable. This effect increases as the frequency and the amplitude increase. As a result, higher harmonic frequencies cause a greater degree of heating in conductors.

On balanced three-phase systems with no harmonic content, the line currents are 120 degrees out-of-phase, canceling each other and resulting in very little neutral current. However, when there is distortion in any one of the phase currents, the harmonic currents increase and the cancellation effect is lessened. The result is typically a neutral current that is significantly higher than planned. The triple harmonics (odd multiples of three) are additive in the neutral and can quickly cause dangerous overheating.

In theory, the maximum current that the neutral will carry is 1.73 times the phase current. If not sized correctly, overheating will result. Higher than normal neutral current will cause voltage drops between neutral and ground which are well above normal. Readings above four volts indicate high neutral current.

False tripping of circuit breakers is also a problem encountered with the higher frequencies that harmonics produce. Peak sensing circuit breakers often will trip even though the amperage value has not been exceeded. Harmonic current peak values can be many times higher than sinusoidal waveforms.

Power factor correction capacitor failure in many cases can be directly attributed to harmonic content. Capacitors appear as extremely low impedance values and are more susceptible to harmonics. Inductive reactance varies directly with frequency ($X_L = 2\pi fL$). Parallel resonance between the capacitor bank and the source impedance can cause system resonance resulting in higher than normal currents and voltages. High harmonic currents have been known to overheat correction capacitors, causing premature failure and sometimes resulting in explosion.

Most harmonic problems result when the resonant frequency is close to the fifth or seventh harmonic. These happen to be the largest harmonic amplitude numbers that adjustable speed drives create. When this situation arises, capacitor banks should be resized to shift the resonant point to another frequency.

Detection and Measurement

In harmonic analysis, field measurements are performed to identify frequency and magnitude of harmonic currents generated by susceptible equipment (e.g., electronic equipment, variable speed motors, etc.). Remember that most distribution systems are designed specifically to carry 60Hz.

Most nonlinear harmonic problems can be detected at the electrical panel. Excessive current flow on the neutral can be detected with a True RMS current meter, but may be indicated by a resonant buzzing sound or by discolored connections on the neutral buss.

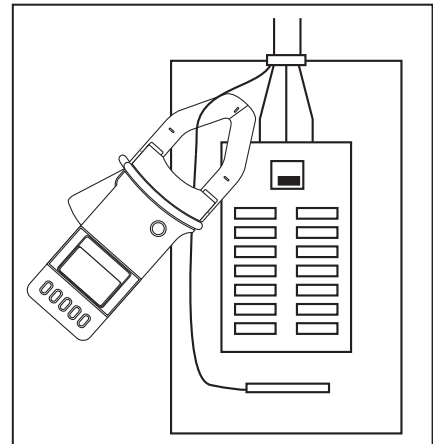

Figure 11. Measuring at the service entrance panel.

Beginning at the service entrance panel, measure and record the True RMS current in each phase, as well as the neutral of the distribution transformer secondary. Compare this measured neutral current to the anticipated current due to phase imbalance. If the phase currents are equal, the vector sum of the neutral currents will add to zero. If there are excessive amounts of triple harmonics in the neutral, neutral current may exceed phase current. Consult the NEC® for the maximum ampacity for each of the tested conductors.

Measure each feeder for harmonic content. A high degree at this location can often be heard as a buzzing sound. A voltage THD reading is also useful at this location.

IEEE standard 519-1992 specifies both maximum distortion levels and recommended correction levels. A harmonic distortion limit of 5% is the point where harmonics begin to have a detrimental effect on electrical distribution systems.

Harmonic current measurements define the harmonic generating characteristics of the load, so measurements should be taken at the load when possible. Voltage measurements define the system response and are usually taken at the individual busses.

Effects on the System

To compound the problems that harmonic currents present to the system, nonlinear harmonic load also have an Ohm's law relationship with the source impedance of the system to produce voltage harmonics. Consider a heavily loaded transformer that is affected by one branch circuit feeding a non-linear load. The creation of voltage harmonics can then be passed down to all the remaining circuits being fed by that transformer.

Voltage harmonics may cause havoc within the electrical system. Motors are typically considered to be linear loads; however, when the source voltage supply is rich in harmonics, the motor will draw harmonic current. The typical result is a higher than normal operating temperature and shortened service life.

Different frequency harmonic currents can cause additional rotating fields in the motor. Depending on the frequency, the motor will rotate in the opposite direction (counter-torque). The fifth harmonic, which is very prevalent, is a negative sequence harmonic causing the motor to have a backward rotation, shortening the service life.

Noise can be picked up in communication equipment and telephone systems when harmonics at audio or radio frequencies are inductively or capacitively coupled into communication or data lines.

When induction-disc watt-hour meters are monitoring nonlinear loads, depending on the content of the harmonics, the disk may run slower or faster, resulting in erroneous readings.

Transformer Derating

Most generators and transformers base their operating characteristics on undisturbed 60Hz waveforms. When the waveforms are rich in harmonics, shortened service or complete failure often follows.

The derating K factor can be applied specifically to transformers to ensure that dangerous heating will not result due to the transformer supplying load currents rich in harmonic content.

The K factor is determined by measuring the True RMS current of each harmonic, multiplied by the harmonic order and squared. The total sum of this is then multiplied by the harmonic order and squared. The total sum of this is then multiplied by the eddy current losses. Transformer parasitic heating due to harmonic currents is frequency dependent, i.e., higher frequency harmonic currents cause a higher degree of transformer heating and failure.

The K factor is basically an index of the transformer's ability to handle nonlinear load current without abnormal heating. Some distribution transformers are now being designed with magnetic cores and windings to accommodate harmonic content. A K-rated transformer is specifically designed to handle nonlinear loads. The higher the K factor value, the better the transformer's ability to handle nonlinear loads.

IEEE C57.110-1986 is a prescribed procedure used to derate the transformer loading based on the specific harmonic content. Each specific electrical application is unique in type and amount of harmonic interaction.

IEEE C57.1200-1987 has proposed a limit of 5% for transformer harmonic current factor.

An alternate method for derating transformers is available for buildings which supply single phase, 120V receptacles. This method is established by The Computer & Business Equipment Manufacturers Association (CBEMA).

$$\text{CBEMA Derating Factor} = \frac{1.414}{\text{Crest Factor}}$$

Meter Readings

Harmonic problems can be analyzed more easily when the proper test equipment is used.

The term "True RMS", or Root-Mean-Square, relates to the equivalent DC heating value of the current or voltage waveform. If a pure sine wave and a distorted sine wave were both applied to a resistive load, the point where they both create the same heating value is the point where they both have the same RMS value.

True RMS capability is required to accurately measure systems where harmonic current is present. Average responding instruments will yield erroneous measurement results from 25 to 40% below the actual value when harmonic distortion is present.

Many instruments on the market measure average or Peak values of a waveform and internally multiply by 1.11 or .707 respectively to indicate RMS values. These devices work well when measuring a pure sine wave.

Instruments with True RMS converters sample the waveform at many different points and provide accurate readings on distorted waveforms. Microprocessor based circuits sample, digitize and square each sample, add it to the previous sample squared, and take the square root of the total. This process yields a True RMS value regardless of the amount of distortion.

Crest Factor

Crest factor is the ratio of the Peak value of a sinusoidal waveform to its RMS value.

$$\text{Crest Factor (CF)} = \frac{\text{Peak value}}{\text{RMS value}}$$

Crest factor indicates the level of peaking which an instrument can handle without measurement errors. For a perfect sine wave the crest factor would be 1.414. This relates to the Peak amplitude that an instrument can measure accurately. Typical crest factor ratings are from 2.0 to 6.0. The higher the factor, the more capable the instrument of measuring a complex waveform correctly. When harmonics are present crest factors may be less than (CF of a square wave = 1) or greater than 1.414.

Limiting the Effects of Harmonics

Derating certain types of electrical equipment is the easiest way to limit the effects that increased heating has on the equipment. A 25% derating for transformers and generators is commonly employed in industry.

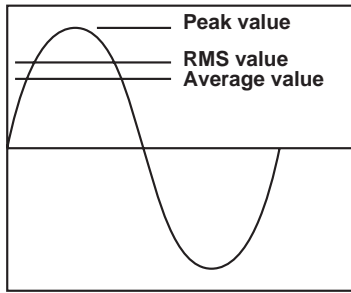

Figure 12. RMS – Avg – Peak Relationship in sine wave

Filtering is currently the most common method used to limit the effects that harmonics present to the rest of the system. Filters typically consist of tuned series L – C circuits. Filter

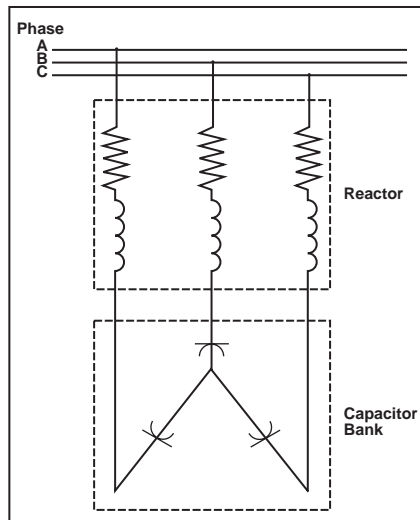

Figure 13. Single tuned shunt filter.

impedance is negligible with respect to the rest of the system, limiting its interaction effects for harmonic control. Filters are sized to withstand the RMS current as well as the value of current for the harmonics.

In the future, systems may be available which will offset the harmonics by applying signals that are equal in amplitude but opposite in phase, thereby canceling or severely limiting harmonic effects.

©2002 Chauvin Arnoux® Inc.
d.b.a. AEMC® Instruments

Contact Us

United States & Canada:

Chauvin Arnoux®, Inc.
d.b.a. AEMC® Instruments
200 Foxborough Blvd.
Foxborough, MA 02035 USA
(508) 698-2115 • Fax (508) 698-2118
www.aemc.com

Customer Support - for placing an order, obtaining price & delivery:
customerservice@aemc.com

Sales Department – for general sales information:
sales@aemc.com

Repair and Calibration Service - for information on repair & calibration, obtaining a user manual:
repair@aemc.com

Technical and Product Application Support –for technical and application support:
techinfo@aemc.com

Webmaster - for information regarding www.aemc.com:
webmaster@aemc.com

South America, Australia & New Zealand:

Chauvin Arnoux®, Inc.
d.b.a. AEMC® Instruments
15 Faraday Drive
Dover, NH 03820 USA
(978) 526-7667 • Fax (978) 526-7605
export@aemc.com

All other countries:

Chauvin Arnoux
190, rue Championnet
75876 Paris Cedex 18, France
33 1 44 85 45 28 • Fax 33 1 46 27 73 89
info@chauvin-arnoux.com